



WIATA KVH

SŁUPKI 12 x 12 cm 215 cm

500 x 500



NIEZBĘDNE NARZĘDZIA

Ołówek, metrówka, poziomica, młotek, wkrętaka, drabina, młot do kotew wbijanych lub wiertarka do mocowania kotew do twardego podłoża.



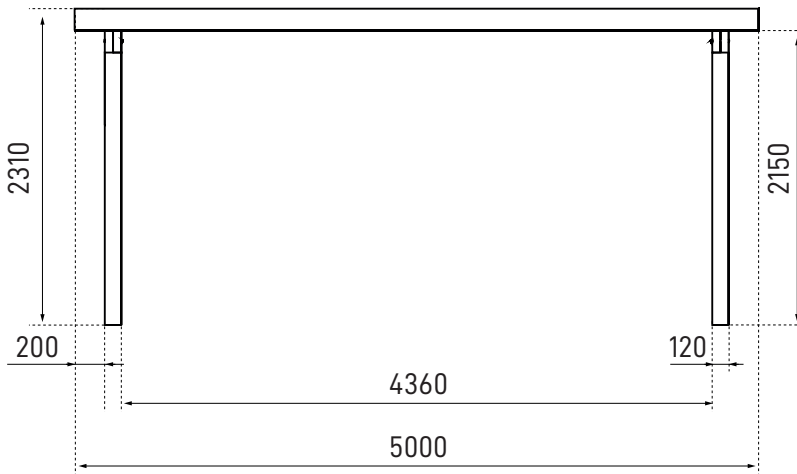
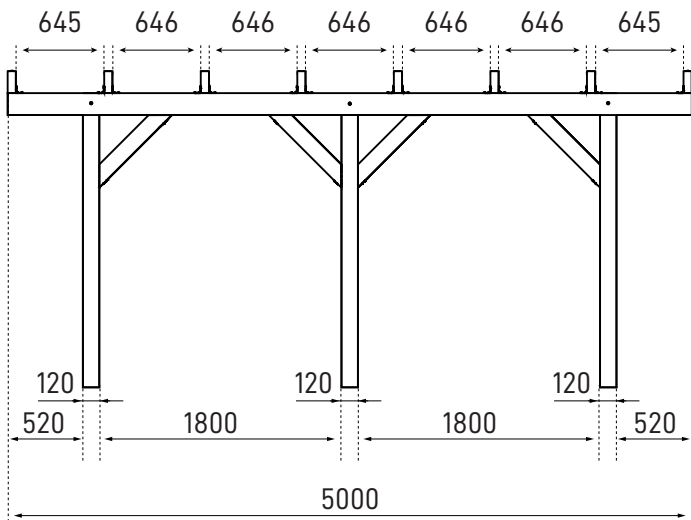

WYKAZ ELEMENTÓW

LP	NAZWA	WYMIAR	SZT.
1	Słup	120 x 120 x 2150 mm	6
2	Belka nośna	60 x 160 x 5000 mm	2
3	Krokiew	60 x 160 x 5000 mm	8
4	Zastrzał	60 x 120 x 750 mm	8
A	Nakrętka	M8	6
B	Podkładka	M8	6
C	Śruba	8 x 130	6
D	Wkręt	5 x 50	224
E	Wkręt	5 x 100	16
F	Torx	8 x 160	16
G	Torx	8 x 240	4
H	Kątownik KP4		28

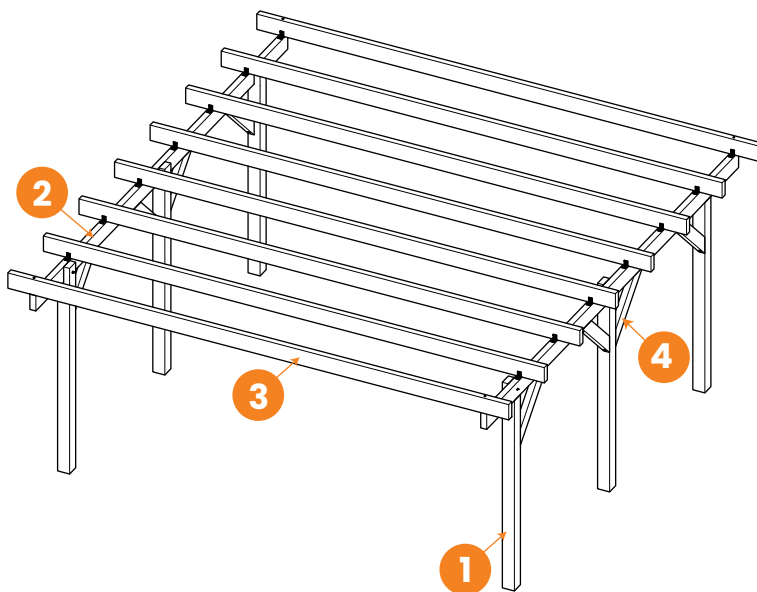

1

MONTAŻ BELKI NOŚNEJ, SŁUPÓW I ZASTRZAŁÓW

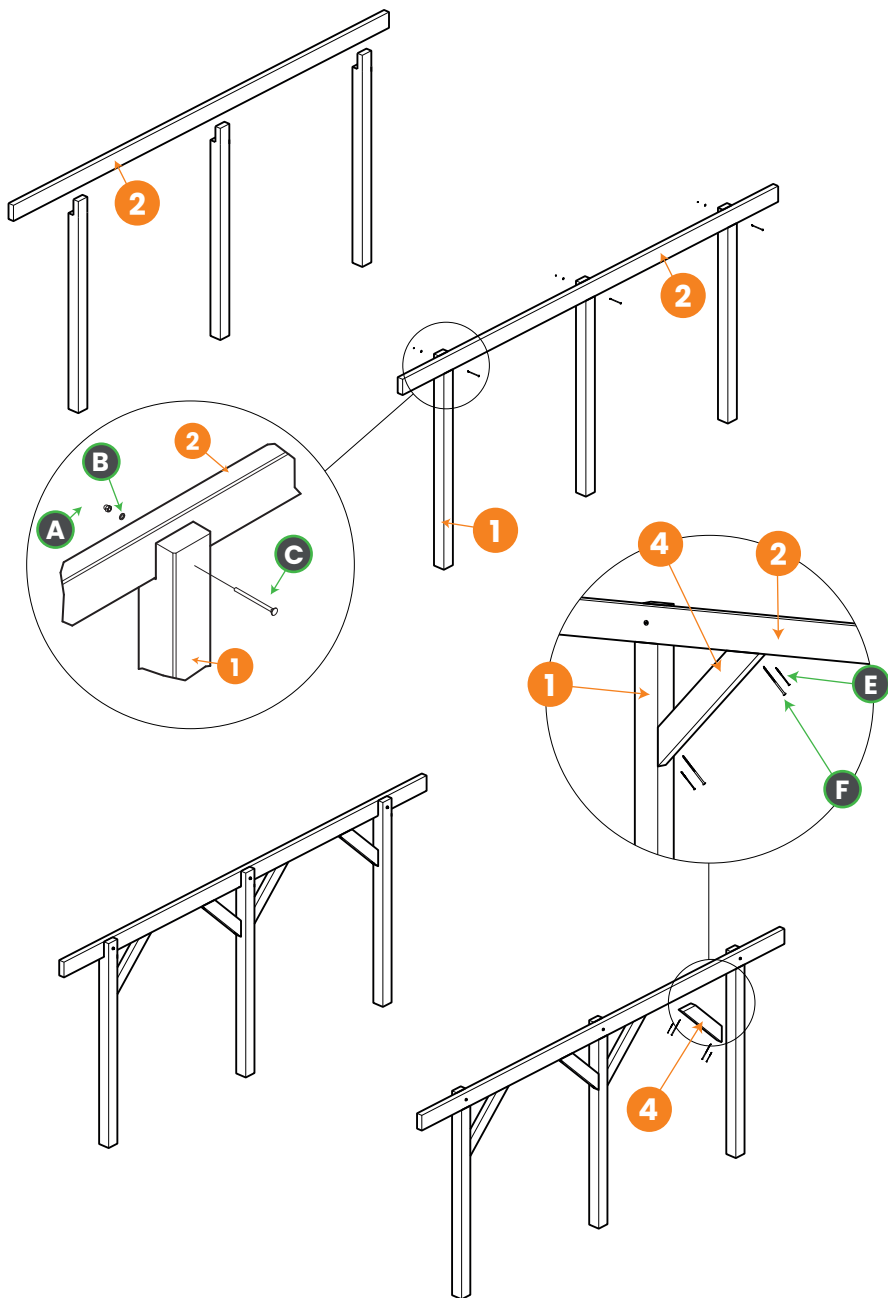

2

MONTAŻ BELKI KROKWI

