



DOMEK KRYSIA

175 x 233 cm



UWAGA!!





Przed rozpoczęciem pracy należy szczegółowo zapoznać się z instrukcją.



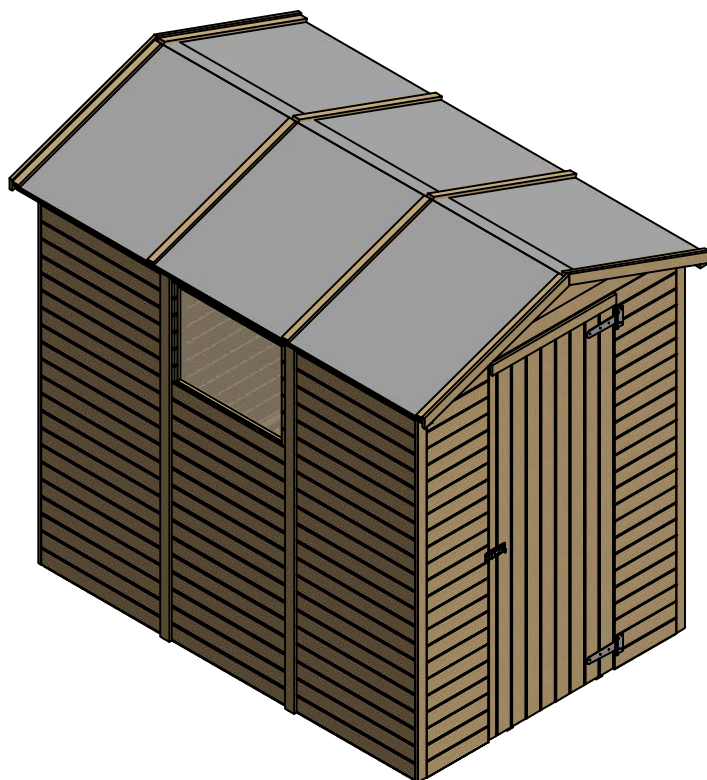

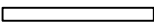
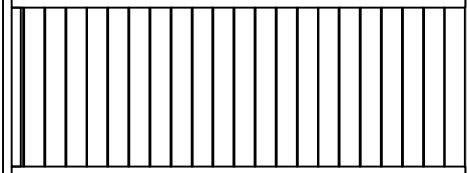
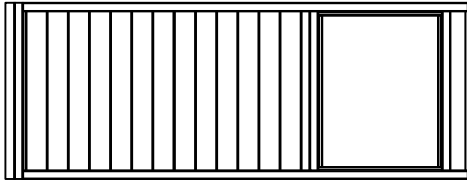
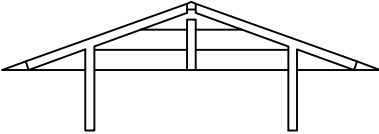

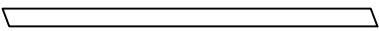

PRZYDATNE NARZĘDZIA

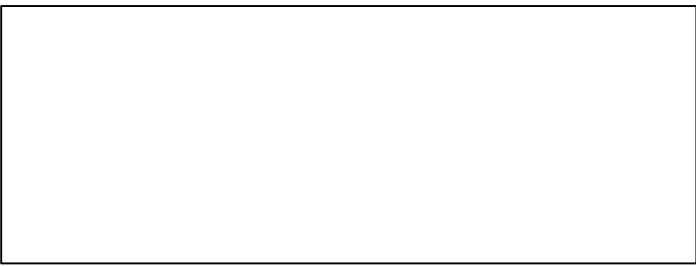

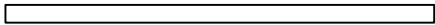
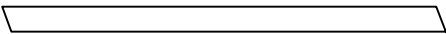
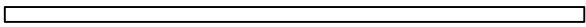
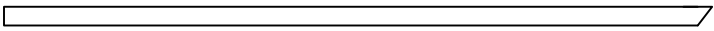
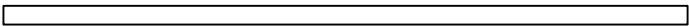
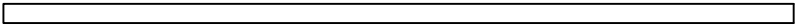
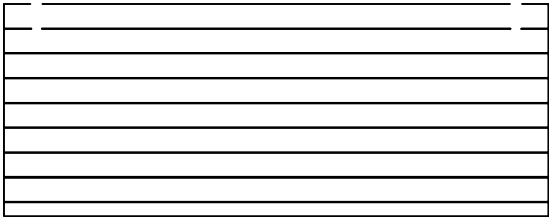
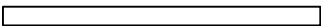
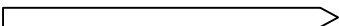
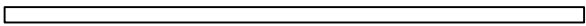
1750 x 2330 x H2160 mm

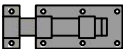
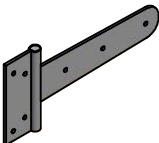

NR	DIMENSION	PCS	PHOTO
A	1470x700	3	
B	35x35x400	6	
C	50x700x1830	7	
D	50x700x1830	1	
E	50x270x1400	2	
F	50x360x1830	1	
G	50x360x1830	1	
H	45x70x2100	1	
J	35x35x730	4	

NR	DIMENSION	PCS	PHOTO
K	10x300x2300	2	
L	10x600x2300	2	
M	1000x2300	2	
N	15x35x900	8	
O	15x50x930	4	
P	15x35x1150	4	
R	15x50x1835	4	
S	15x50x1780	4	
T	15x50x1500	1	
U	50x700x1810	1	
W	15x50x700	1	
X	15x50x580	1	
Y	35x35x1150	4	
I	4,0 x 15	3	
II	4,0 x 25	98	
III	4,0 x 35	86	
IV	4,0 x 45	13	
V	4,0 x 55	72	
VI	4,0 x 90	8	
VII	100x40	1	
VIII	hinge	2	

III - 4,0x35 #24 

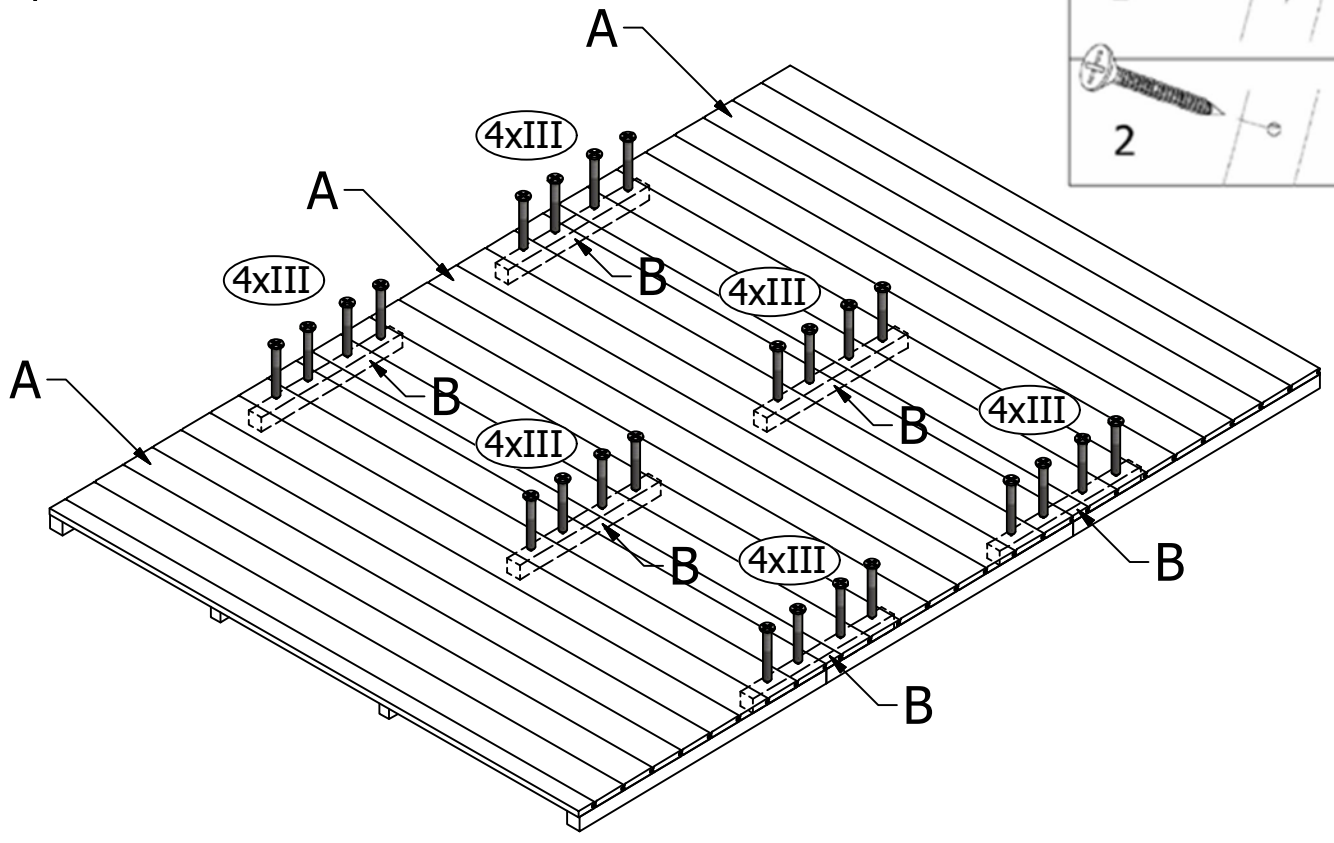
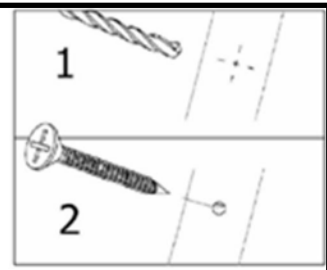

V - 4,0x55 #31 

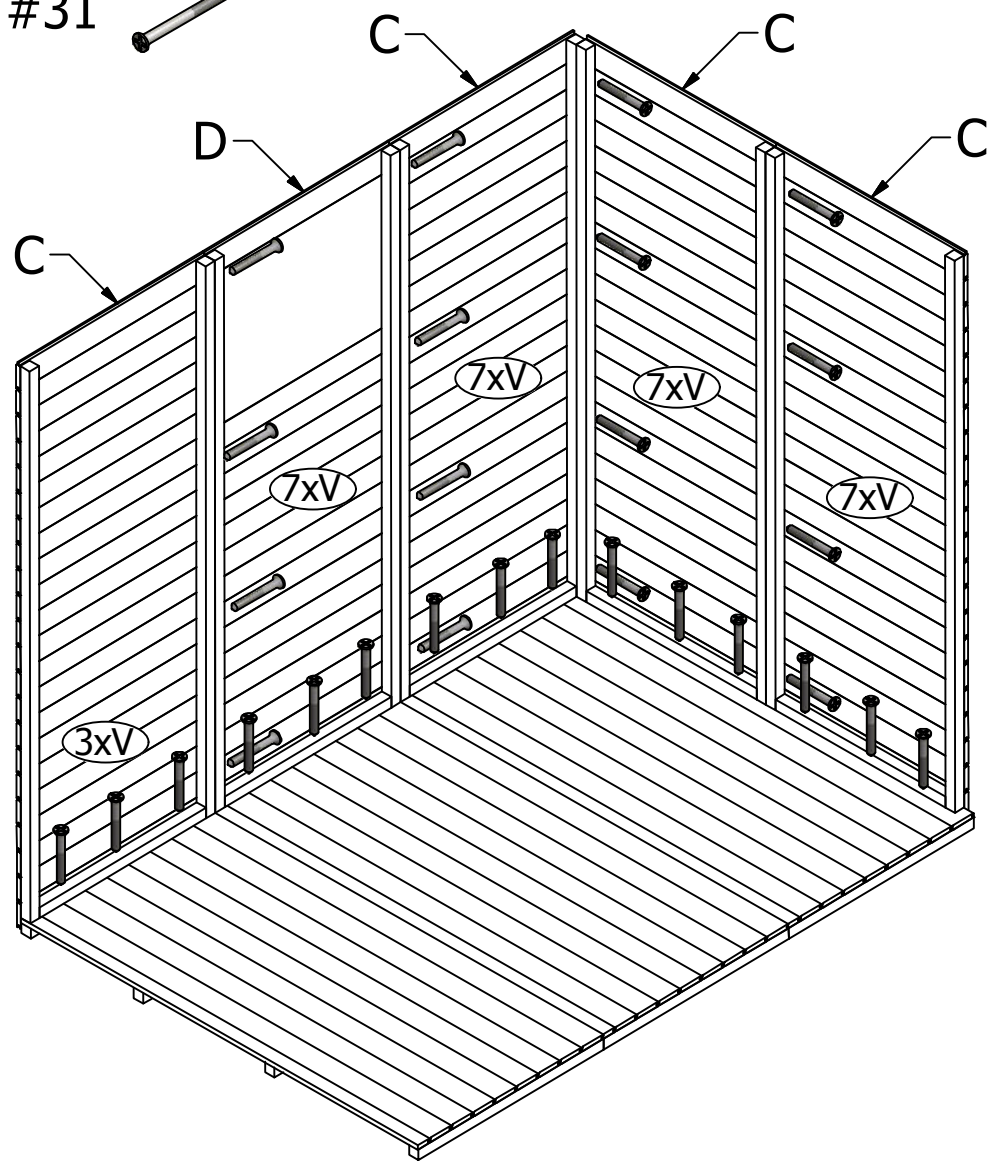

V - 4,0x55 #33 

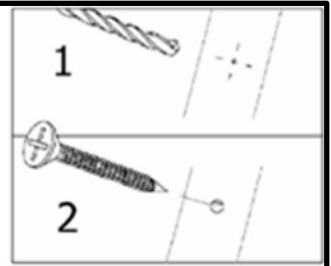
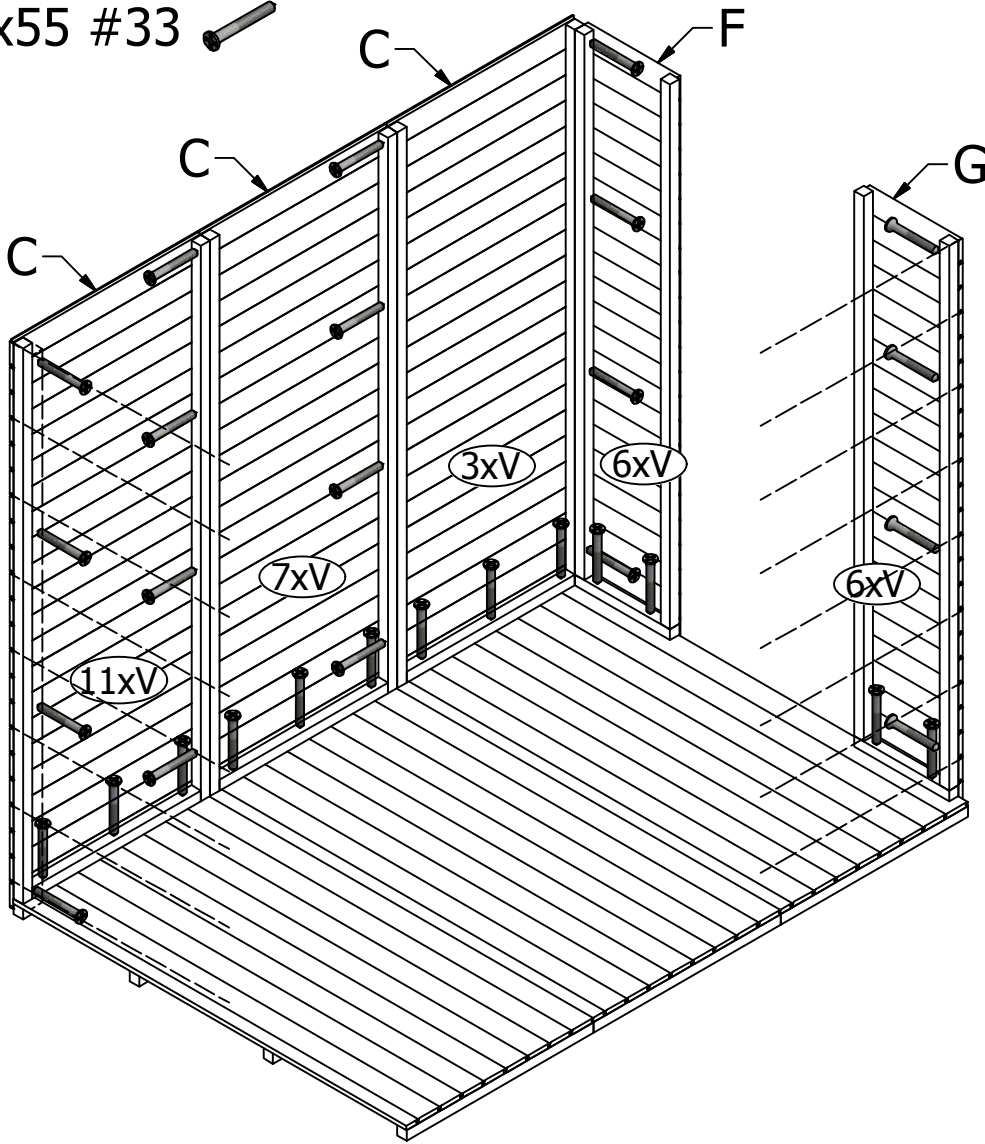

III - 4,0x35 #6 

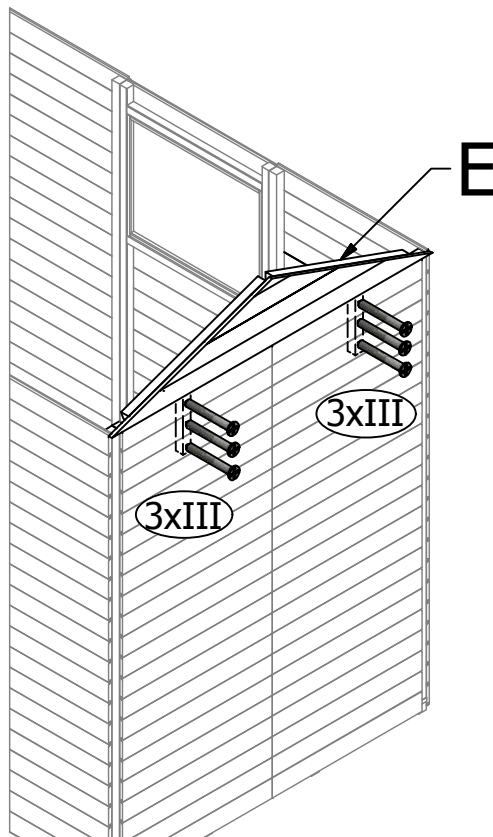

V - 4,0x55 #6

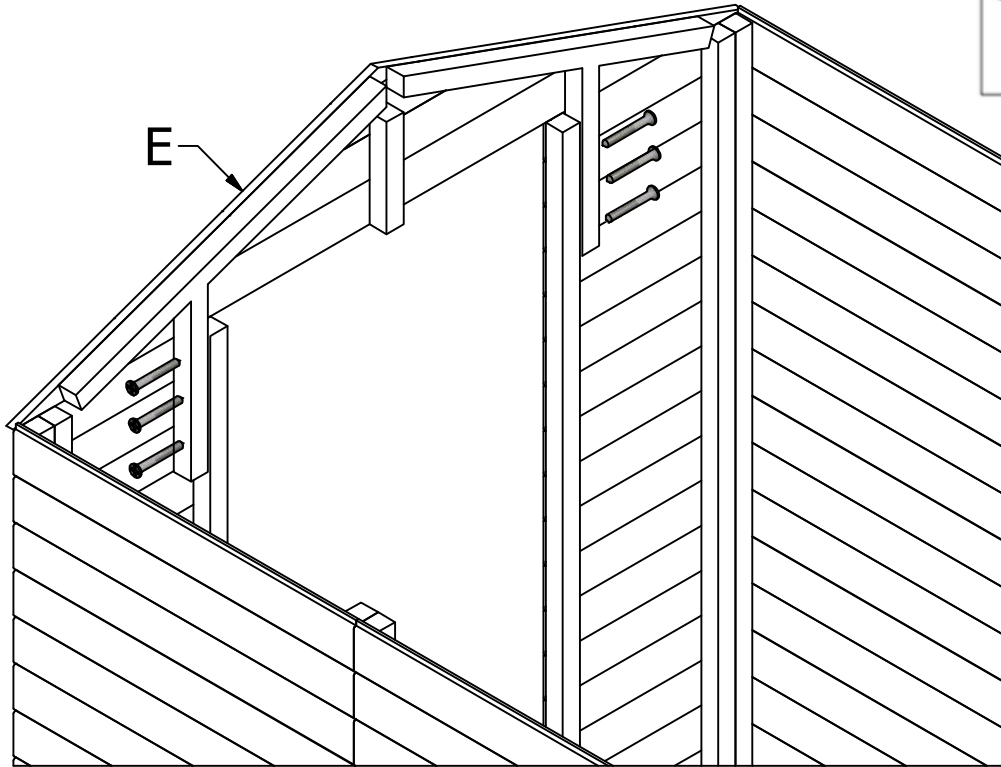
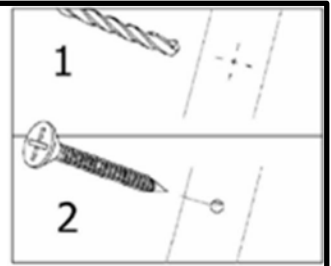

V - 4,0x55 #2

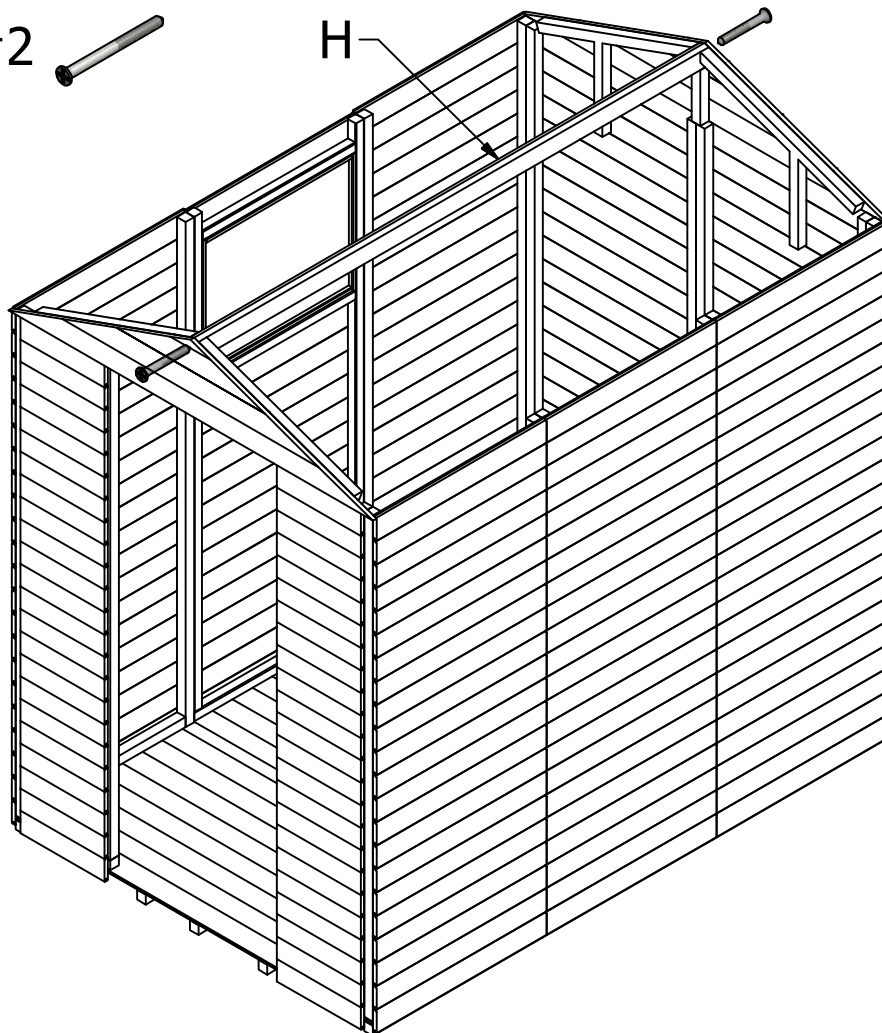

VI - 4,5x90 #8

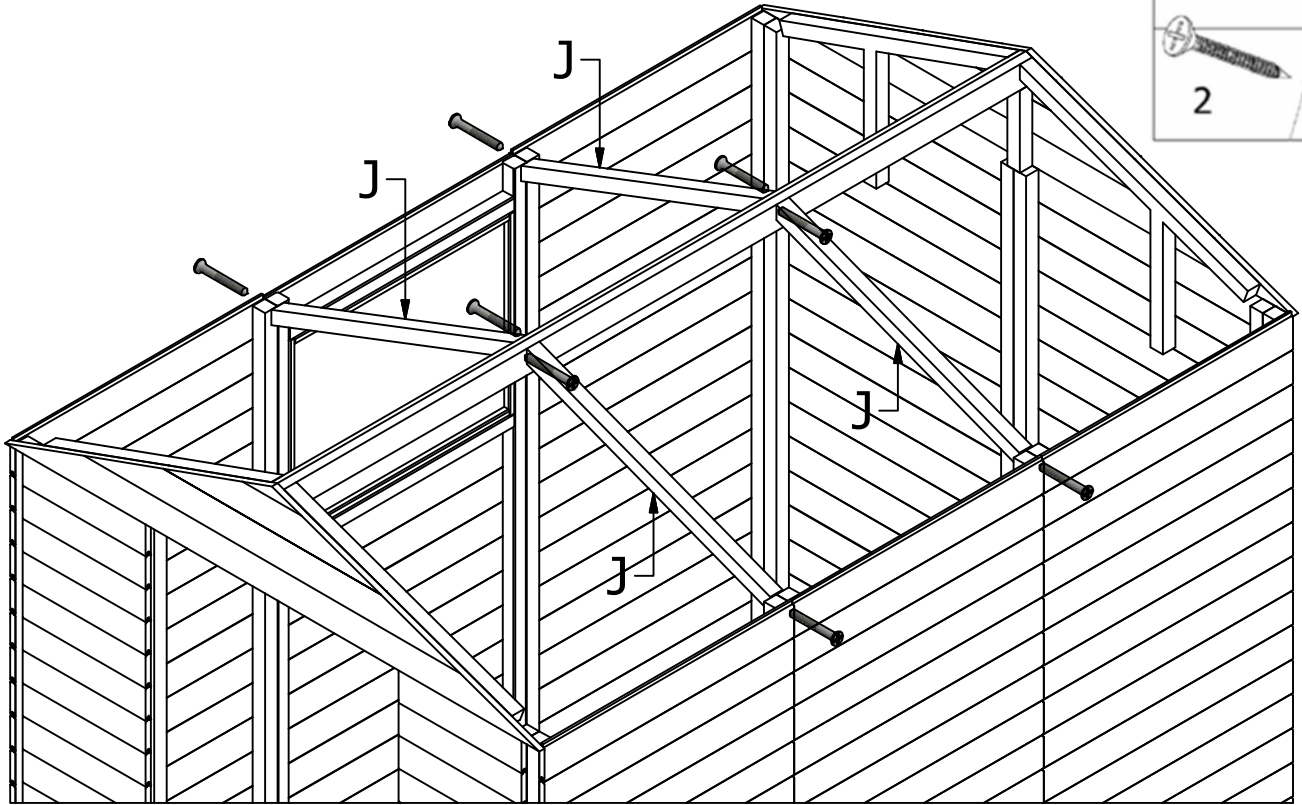
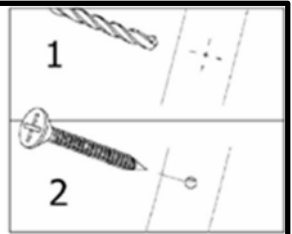

III - 4,0x35 #12

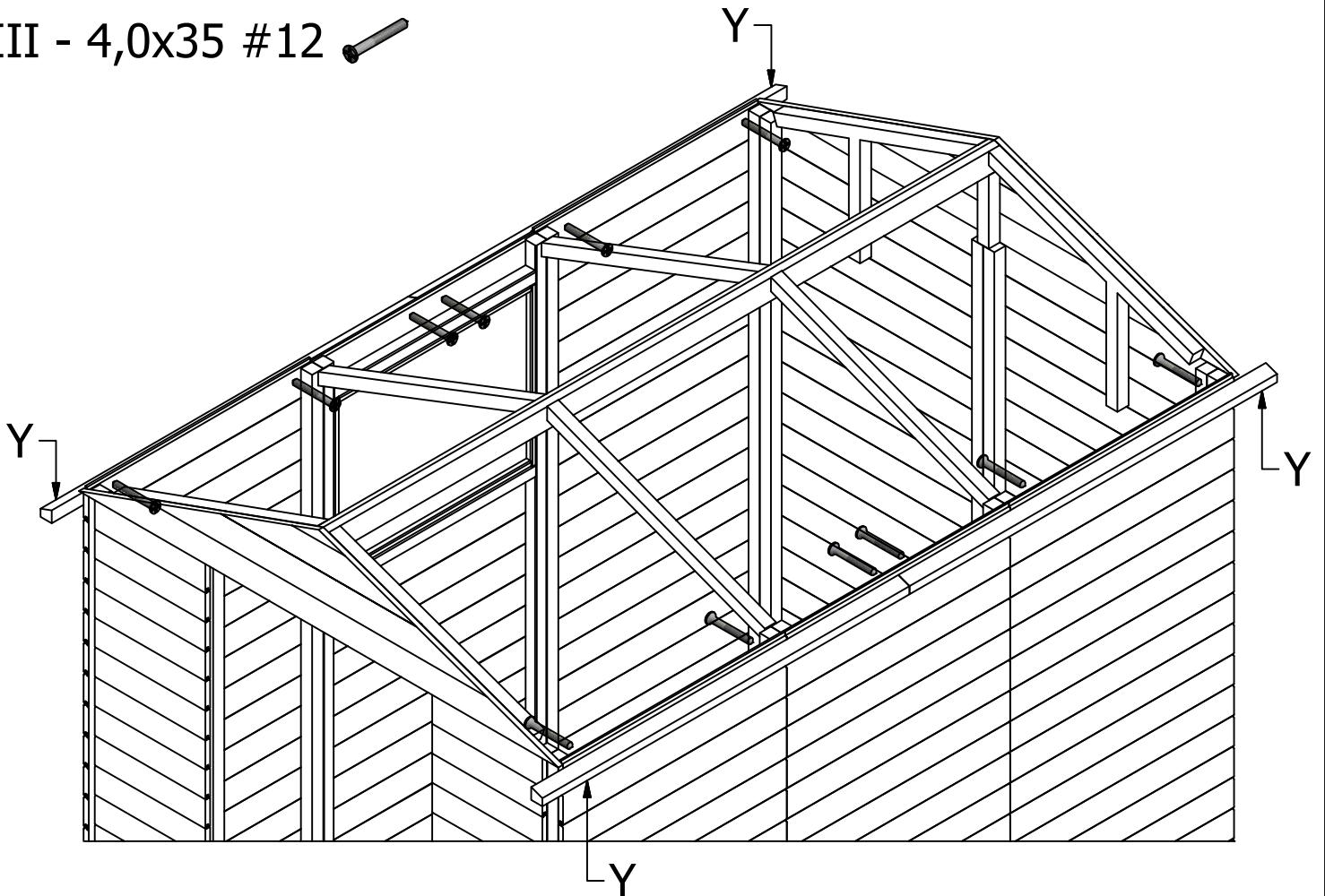

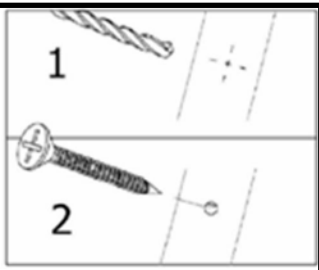
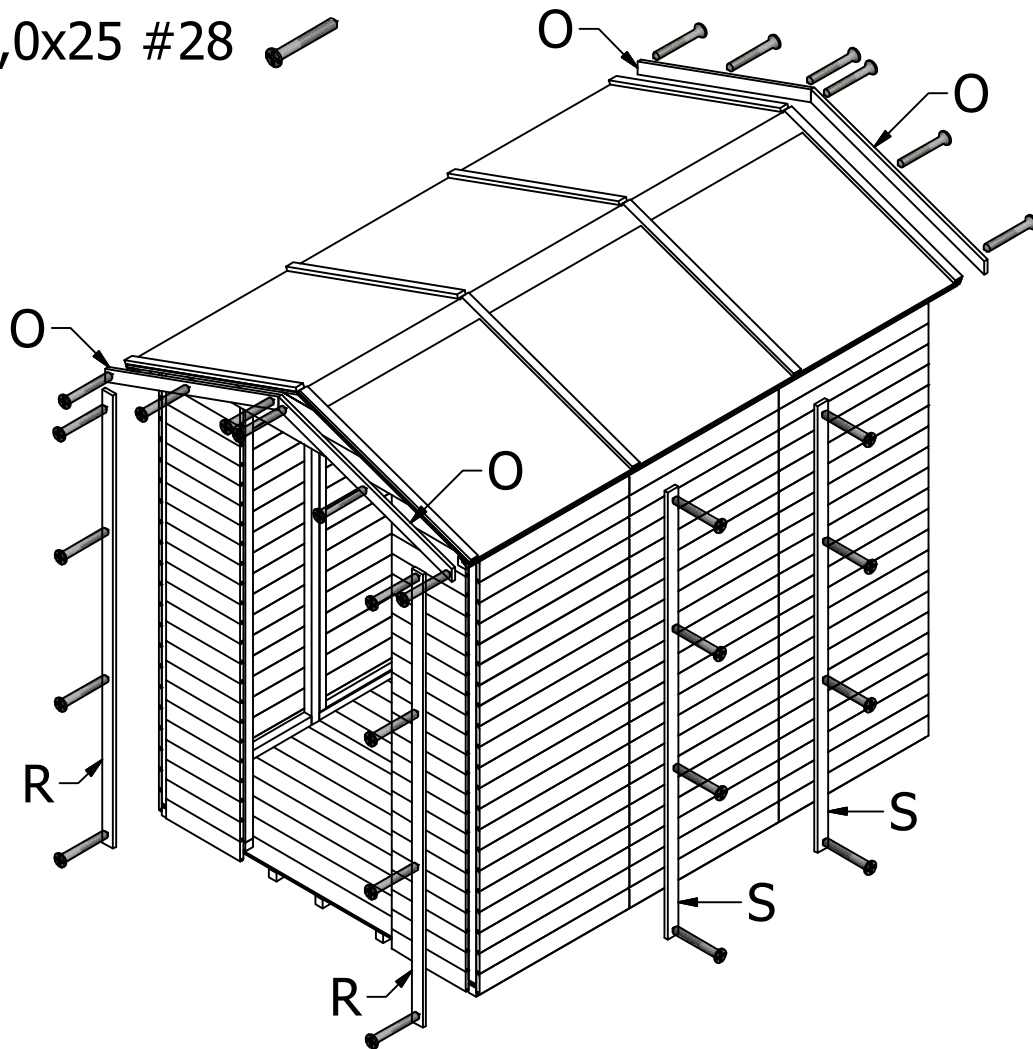

II - 4,0x25 #28

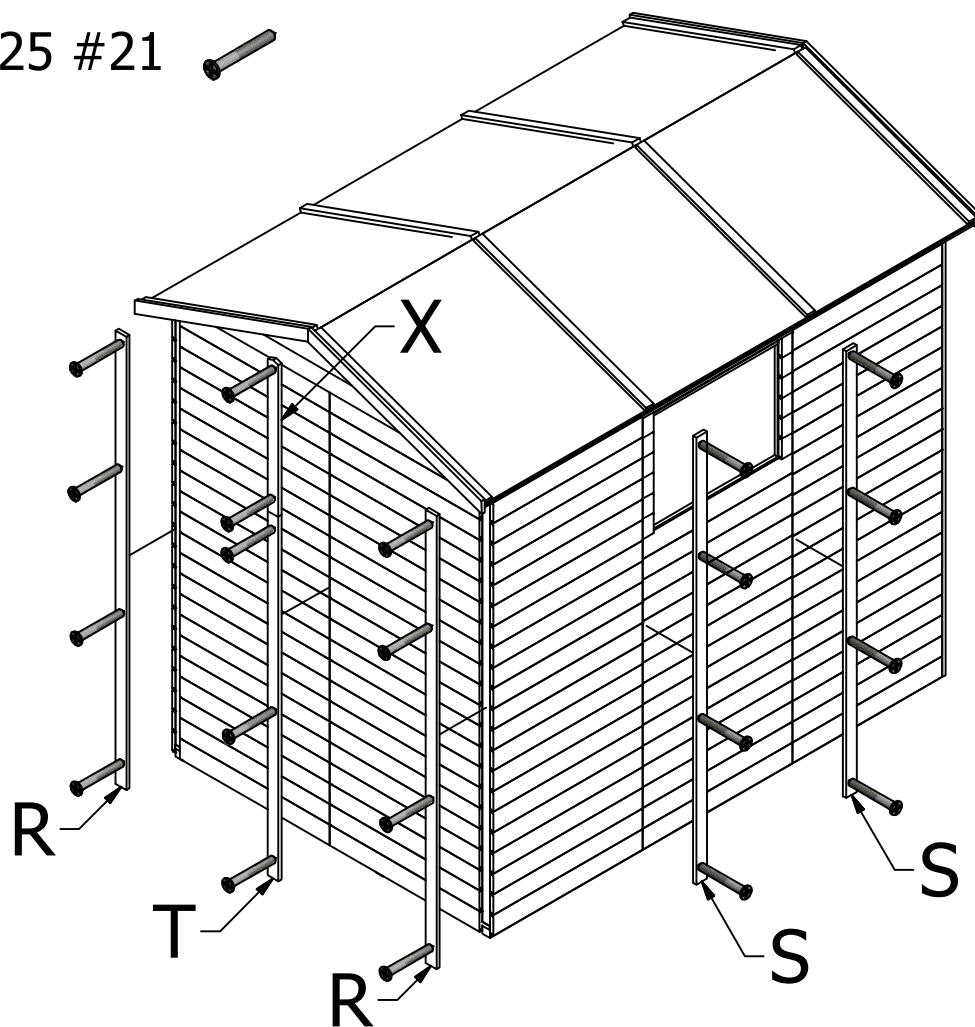

II - 4,0x25 #21

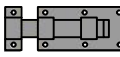
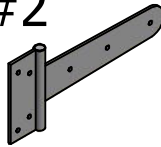

I - 4,0x15 #3  IV - 4,0x45 #13 
 II - 4,0x25 #6  VII - 100x40 #1 
 VIII #2 

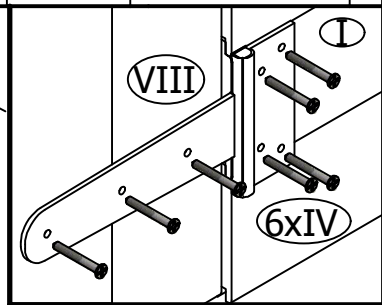
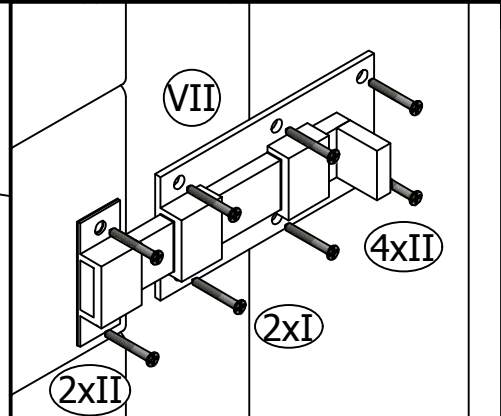
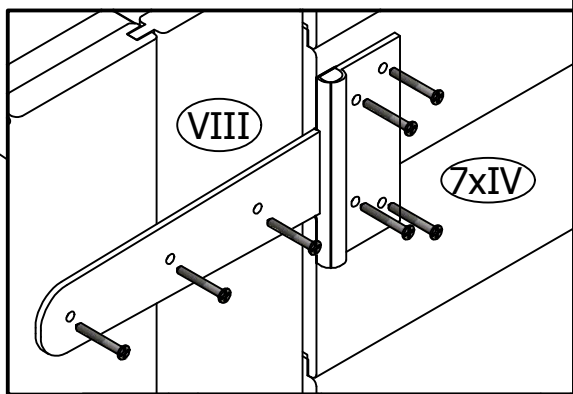
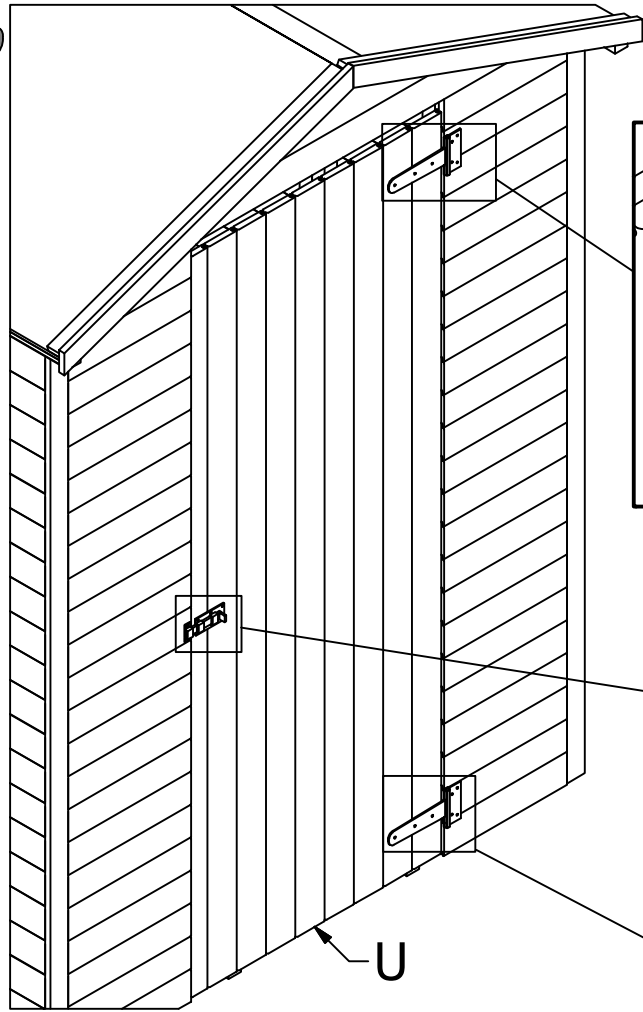
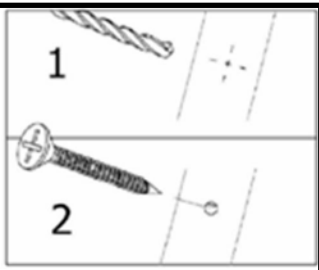

II - 4,0x25 #3 

